

AAE Model No. PTB-15
15' Portable Team Bench

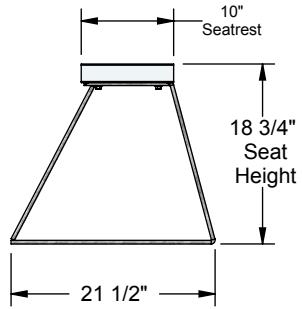

Aluminum Athletic Equipment
1000 Enterprise Drive, Royersford, PA 19468
Toll Free: (800) 523-5471 Fax: (610) 825-2378
www.AAEsports.com

PTB-15 - 15' Team Bench Specifications



Side View Details

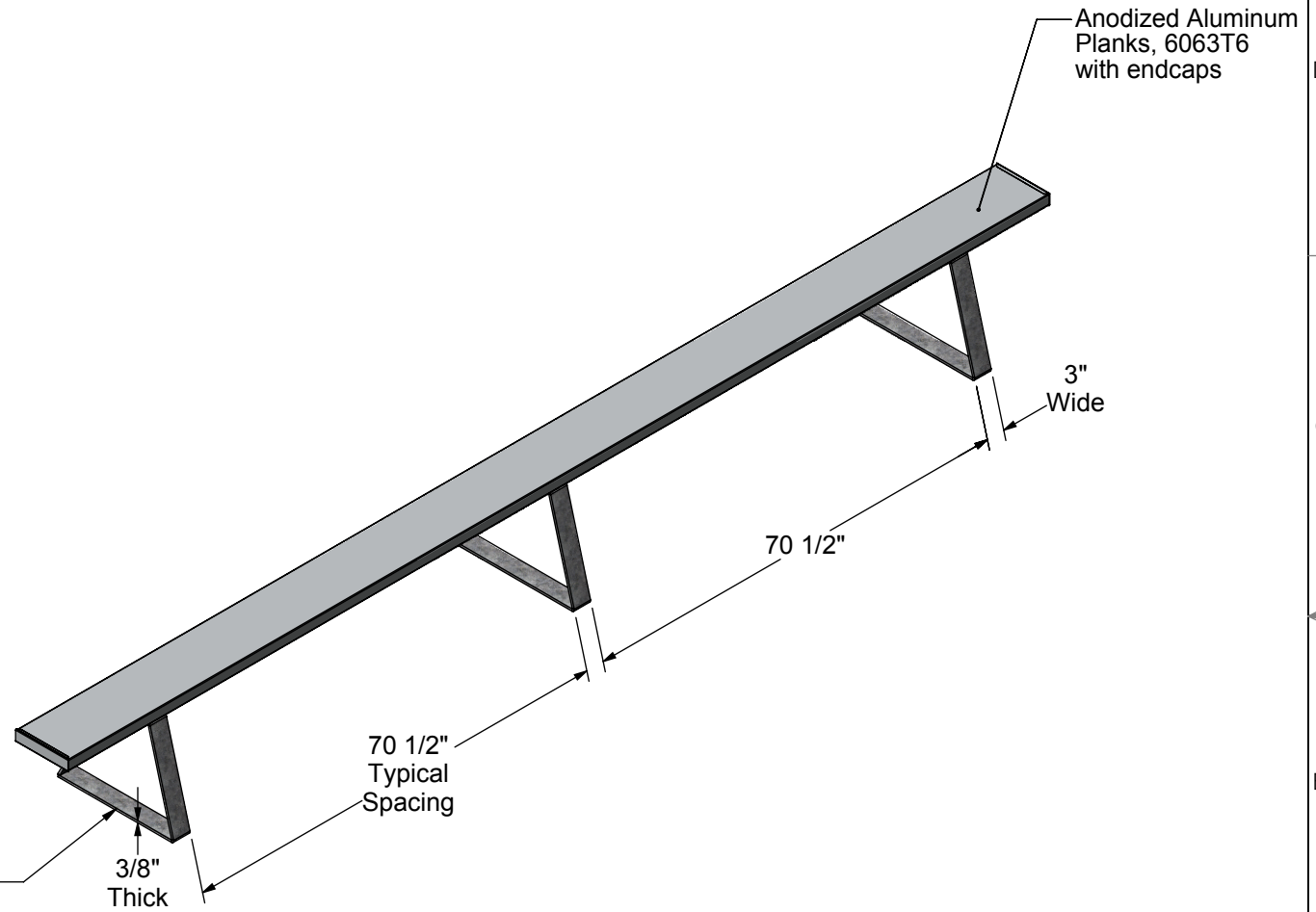

Equipment Details

Materials: Anodized Aluminum, 6063T6
Galvanized Steel, 3/8" x 3" HRS
Aluminum & Stainless Steel Hardware.

Overall Weight: 95 lbs.
Overall Size: 18-3/4" high x 21-1/2" deep x 15' long

LIFETIME WARRANTY



Aluminum Athletic Equipment
1000 Enterprise Drive, Royersford, PA 19468
Toll Free: (800) 523-5471 Fax: (610) 825-2378
www.AAEsports.com

DESCRIPTION:			PTB-15 - Specifications
NOTE:			15' Portable Team Bench
MODEL:	CATEGORY:	DATE:	
PTB-15	CUSTOMER	12/17/2018	
DWN. BY:	CAD FILE:	DWG. NO.:	
CED	PTB-15 - Specifications	PTB-15-C-001	

PTB-15 - 15' Team Bench Assembly

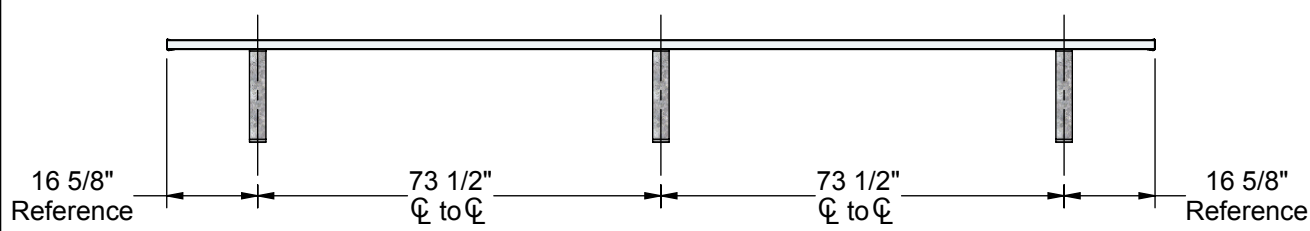
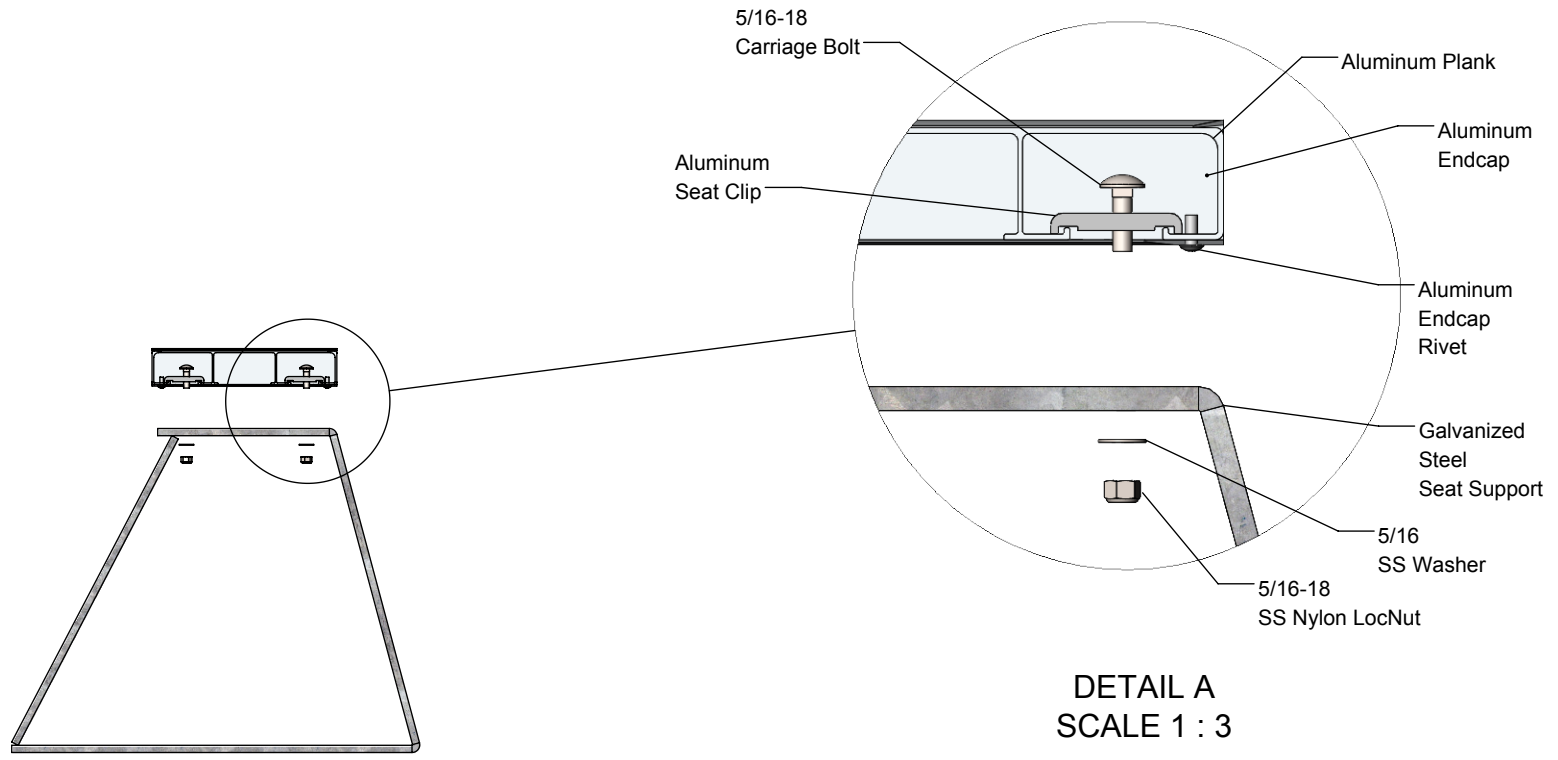



Aluminum Athletic Equipment
1000 Enterprise Drive, Royersford, PA 19468
Toll Free: (800) 523-5471 Fax: (610) 825-2378
www.AAEsports.com

DESCRIPTION:		
PTB-15 - Assembly		
NOTE: Layout Installation		
MODEL:	CATEGORY:	DATE:
PTB-15	CUSTOMER	12/17/2018
DWN. BY:	CAD FILE:	DWG. NO.:
CED	PTB-15 - Assembly	PTB-15-C-002